

HM628128 Series

131072-word × 8-bit High Speed CMOS Static RAM

The Hitachi HM628128 is a CMOS static RAM organized 128-kword × 8-bit. It realizes higher density, higher performance and low power consumption by employing 0.8 μm Hi-CMOS process technology.

It offers low power standby power dissipation; therefore, it is suitable for battery back-up systems. The device, packaged in a 525-mil SOP (460-mil body SOP) or a 600-mil plastic DIP, or a 8 × 20 mm TSOP with thickness of 1.2 mm, is available for high density mounting. The TSOP package is suitable for cards, and reverse type TSOP is also provided.

Features

- High speed: fast access time 70/85/100/120 ns (max)
- Low power
 - Standby: 10 μW (typ) (L/L-L/L-SL version)
 - Operation: 75 mW (typ)
- Single 5 V supply
- Completely static memory
 - No clock or timing strobe required
- Equal access and cycle times
- Common data input and output: Three state output
- Directly TTL compatible: All inputs and outputs
- Capability of battery back up operation (L/L-L/L-SL version) (2 chip selection for battery back up)

HM628128 Series

Ordering Information

Type No.	Access time	Package	Type No.	Access time	Package
HM628128P-7	70 ns	600-mil, 32-pin plastic DIP (DP-32)	HM628128FP-7	70 ns	525 mil, 32-pin plastic SOP (FP-32D)
HM628128P-8	85 ns		HM628128FP-8	85 ns	
HM628128P-10	100 ns		HM628128FP-10	100 ns	
HM628128P-12	120 ns		HM628128FP-12	120 ns	
HM628128LP-7	70 ns		HM628128LFP-7	70 ns	
HM628128LP-8	85 ns		HM628128LFP-8	85 ns	
HM628128LP-10	100 ns		HM628128LFP-10	100 ns	
HM628128LP-12	120 ns		HM628128LFP-12	120 ns	
HM628128LP-7SL	70 ns		HM628128LFP-7SL	70 ns	
HM628128LP-8SL	85 ns		HM628128LFP-8SL	85 ns	
HM628128LP-10SL	100 ns		HM628128LFP-10SL	100 ns	
HM628128LP-12SL	120 ns		HM628128LFP-12SL	120 ns	
HM628128T-7	70 ns	8mm x 20mm 32-pin TSOP (normal type) (TFP-32D)	HM628128R-7	70 ns	8mm x 20 mm 32-pin TSOP (reverse type) (TFP-32DR)
HM628128T-8	85 ns		HM628128R-8	85 ns	
HM628128T-10	100 ns		HM628128R-10	100 ns	
HM628128T-12	120 ns		HM628128R-12	120 ns	
HM628128LT-7	70 ns		HM628128LR-7	70 ns	
HM628128LT-8	85 ns		HM628128LR-8	85 ns	
HM628128LT-10	100 ns		HM628128LR-10	100 ns	
HM628128LT-12	120 ns		HM628128LR-12	120 ns	
HM628128LT-7L	70 ns		HM628128LR-7L	70 ns	
HM628128LT-8L	85 ns		HM628128LR-8L	85 ns	
HM628128LT-10L	100 ns		HM628128LR-10L	100 ns	
HM628128LT-12L	120 ns		HM628128LR-12L	120 ns	
HM628128LT-7SL	70 ns		HM628128LR-7SL	70 ns	
HM628128LT-8SL	85 ns		HM628128LR-8SL	85 ns	
HM628128LT-10SL	100 ns		HM628128LR-10SL	100 ns	
HM628128LT-12SL	120 ns		HM628128LR-12SL	120 ns	

HM628128 Series

Pin Arrangement

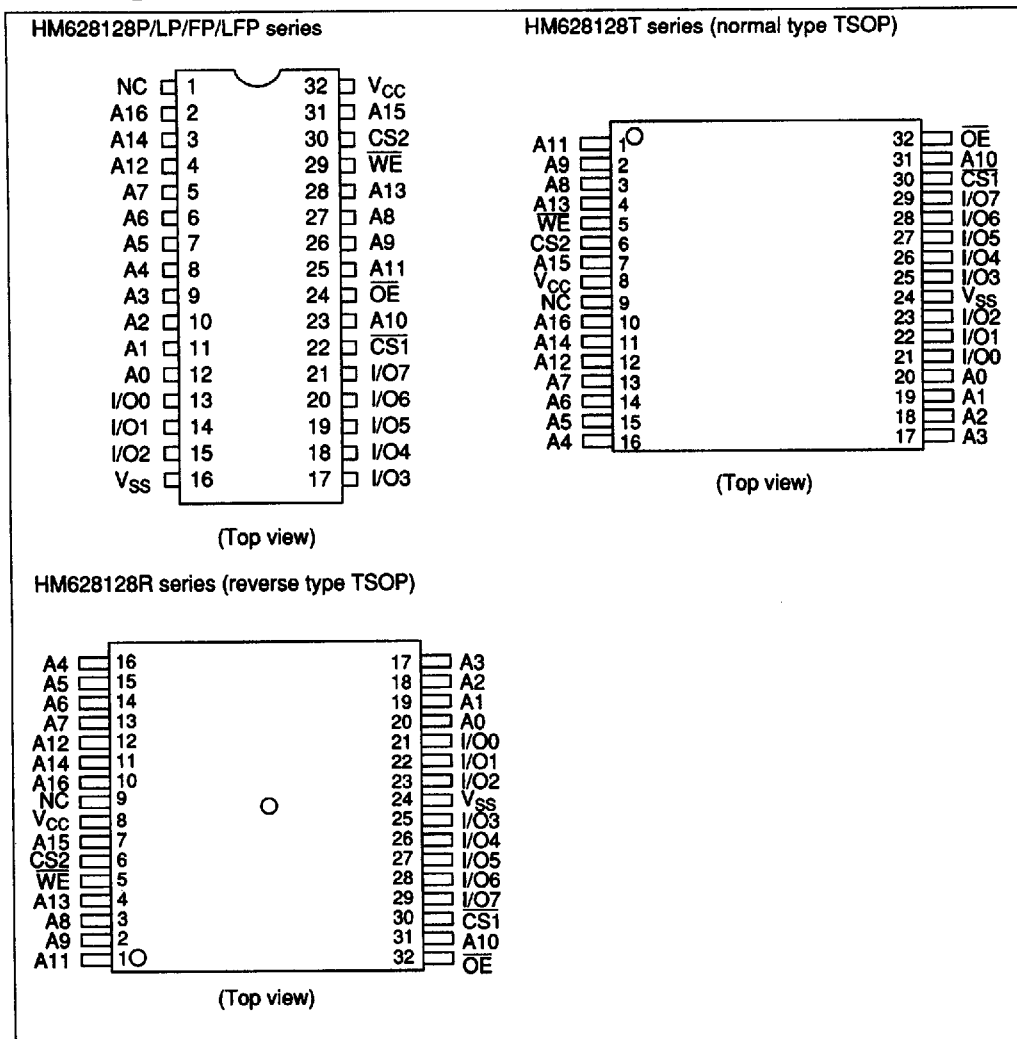

5

Pin Description

Pin name	Function	Pin name	Function
A0–A16	Address	OE	Output enable
I/O0–I/O7	Input/output	NC	Not connected
CS1	Chip select 1	V _{CC}	Power supply
CS2	Chip select 2	V _{SS}	Ground
WE	Write enable		

HM628128 Series

Block Diagram

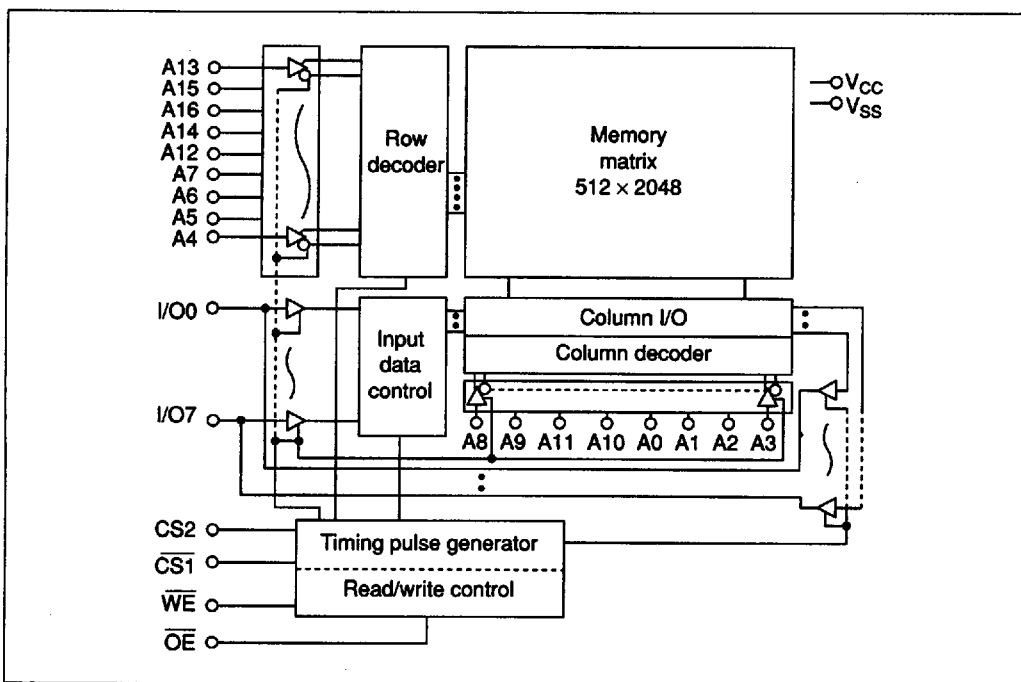

Truth Table

\overline{WE}	$\overline{CS1}$	$CS2$	\overline{OE}	Mode	V_{CC} current	Dout pin	Cycle
x	H	x	x	Not selected	I_{SB}, I_{SB1}	High-Z	—
x	x	L	x		I_{SB}, I_{SB1}	High-Z	—
H	L	H	H	Output disable	I_{CC}	High-Z	—
H	L	H	L	Read	I_{CC}	Dout	Read cycle
L	L	H	H	Write	I_{CC}	D_{IN}	Write cycle (1)
L	L	H	L		I_{CC}	D_{IN}	Write cycle (2)

Note: x: H or L

HM628128 Series

Absolute Maximum Ratings

Parameter	Symbol	Value	Unit
Voltage on any pin relative to V_{SS}	V_T	-0.5 to +7.0	V
Power dissipation	P_T	1.0	W
Operating temperature	T_{opr}	0 to +70	°C
Storage temperature	T_{stg}	-55 to +125	°C
Storage temperature under bias	T_{bias}	-10 to +85	°C

Note: -3.0 V for pulse half-width \leq 30 ns

Recommended DC Operating Conditions ($T_a = 0$ to +70°C)

Parameter	Symbol	Min	Typ	Max	Unit
Supply voltage	V_{CC}	4.5	5.0	5.5	V
	V_{SS}	0	0	0	V
Input high (logic 1) voltage	V_{IH}	2.2	—	6.0	V
Input low (logic 0) voltage	V_{IL}	-0.3*	—	0.8	V

Note: -3.0 V for pulse half-width \leq 30 ns

HM628128 Series

DC Characteristics (Ta = 0 to +70°C, V_{CC} = 5 V ± 10%, V_{SS} = 0 V)

Parameter	Symbol	Min	Typ ¹	Max	Unit	Test conditions
Input leakage current	I _{LI}	—	—	2	μA	V _{IN} = V _{SS} to V _{CC}
Output leakage current	I _{LO}	—	—	2	μA	CS1 = V _{IH} or CS2 = V _{IL} or OE = V _{IH} or WE = V _{IL} , V _{VO} = V _{SS} to V _{CC}
Operating power supply current: DC	I _{CC}	—	15	35	mA	CS1 = V _{IL} , CS2 = V _{IH} , others = V _{IH} /V _{IL} , I _{VO} = 0 mA
Operating power supply current	I _{CC1}	—	45	70	mA	Min. cycle, duty = 100%, CS1 = V _{IL} , CS2 = V _{IH} , others = V _{IH} /V _{IL} I _{VO} = 0 mA
	I _{CC2}	—	15	30	mA	Cycle time = 1 μs, duty = 100%, I _{VO} = 0 mA, CS1 ≤ 0.2 V, CS2 ≥ V _{CC} - 0.2 V, V _{IH} ≥ V _{CC} - 0.2 V, V _{IL} ≤ 0.2 V
Standby power supply current: DC	I _{SB}	—	1	3	mA	CS1 = V _{IH} , CS2 = V _{IH} or CS2 = V _{IL}
Standby power supply current (1): DC	I _{SB1}	—	0.02	2	mA	V _{IN} ≥ 0 V, CS1 ≥ V _{CC} - 0.2 V, CS2 ≥ V _{CC} - 0.2 V or 0 V ≤ CS2 ≤ CS2 = V _{IL}
		—	2 ²	100 ²	μA	
		—	2 ³	50 ³	μA	
Output low voltage	V _{OL}	—	—	0.4	V	I _{OL} = 2.1 mA
Output high voltage	V _{OH}	2.4	—	—	V	I _{OH} = -1.0 mA

- Note: 1. Typical values are at V_{CC} = 5.0 V, Ta = +25°C and specified loading.
 2. These characteristics are guaranteed only for L-version.
 3. These characteristics are guaranteed only for L-L/L-SL version.

Capacitance (Ta = 25°C, f = 1.0 MHz)

Parameter	Symbol	Min	Typ	Max	Unit	Test conditions
Input capacitance	C _{in}	—	—	8	pF	V _{IN} = 0 V
Input/output capacitance	C _{VO}	—	—	10	pF	V _{VO} = 0 V

Note: These parameters are sampled and not 100% tested.

HM628128 Series

AC Characteristics ($T_a = 0$ to $+70^\circ\text{C}$, $V_{CC} = 5\text{ V} \pm 10\%$, unless otherwise noted)

Test Conditions:

- Input pulse levels: 0.8 V to 2.4 V
- Input and output timing reference: 1.5 V
- Input rise and fall times: 5 ns
- Output load: 1 TTL gate and C_L (100 pF) (Including scope and jig)

Read Cycle

Parameter	Symbol	HM628128-7		HM628128-8		HM628128-10		HM628128-12		Unit
		Min	Max	Min	Max	Min	Max	Min	Max	
Read cycle time	t_{RC}	70	—	85	—	100	—	120	—	ns
Address access time	t_{AA}	—	70	—	85	—	100	—	120	ns
Chip selection (CS1) to output valid	t_{CO1}	—	70	—	85	—	100	—	120	ns
Chip selection (CS2) to output valid	t_{CO2}	—	70	—	85	—	100	—	120	ns
Output enable (OE) output valid	t_{OE}	—	35	—	45	—	50	—	60	ns
Chip selection (CS1) to output in low-Z ^{1,2,3}	t_{LZ1}	10	—	10	—	10	—	10	—	ns
Chip selection (CS2) to output in low-Z ^{1,2,3}	t_{LZ2}	10	—	10	—	10	—	10	—	ns
Output enable (OE) to output in low-Z ^{1,2,3}	t_{OLZ}	5	—	5	—	5	—	5	—	ns
Chip deselection (CS1) to output in high-Z ^{1,2,3}	t_{HZ1}	0	25	0	30	0	35	0	45	ns
Chip deselection (CS2) to output in high-Z ^{1,2,3}	t_{HZ2}	0	25	0	30	0	35	0	45	ns
Output disable (OE) to output in high-Z ^{1,2,3}	t_{OHZ}	0	25	0	30	0	35	0	45	ns
Output hold from address change	t_{OH}	10	—	10	—	10	—	10	—	ns

- Notes: 1. t_{HZ} and t_{OHZ} are defined as the time at which the outputs achieve the open circuit conditions and are not referred to output voltage levels.
 2. At any given temperature and voltage condition, t_{HZ} max is less than t_{LZ} min both for a given device and from device to device.
 3. These parameters are sampled and not 100% tested.

5

HM628128 Series

Read Timing Waveform

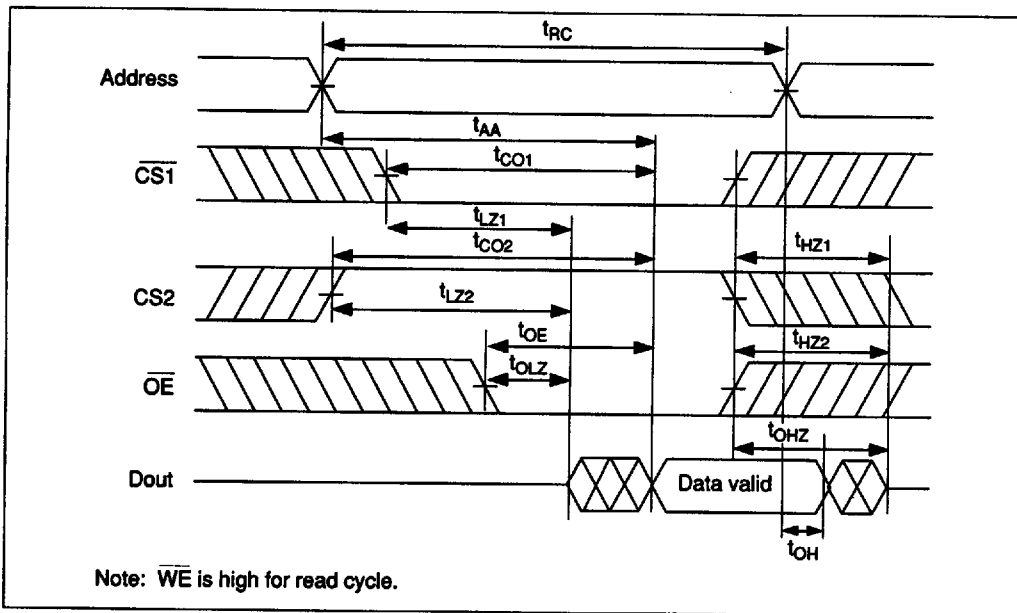

Write Cycle

Parameter	Symbol	HM628128-7		HM628128-8		HM628128-10		HM628128-12		Unit
		Min	Max	Min	Max	Min	Max	Min	Max	
Write cycle time	t _{WC}	70	—	85	—	100	—	120	—	ns
Chip selection to end of write	t _{CW}	60	—	75	—	80	—	85	—	ns
Address setup time	t _{AS}	0	—	0	—	0	—	0	—	ns
Address valid to end of write	t _{AW}	60	—	75	—	80	—	85	—	ns
Write pulse width	t _{WP}	50	—	55	—	60	—	70	—	ns
Write recovery time ^{*1}	t _{WR}	5	—	5	—	5	—	10	—	ns
		10	—	10	—	10	—	15	—	ns ^{*1}
Write to output in high-Z ^{*2}	t _{WHZ}	0	25	0	30	0	35	0	40	ns
Data to write time overlap	t _{DW}	30	—	35	—	40	—	45	—	ns
Write hold from write time	t _{DH}	0	—	0	—	0	—	0	—	ns
Output active from end of write ^{*1}	t _{OW}	5	—	5	—	5	—	5	—	ns

Notes: 1. This value is measured from CS2 going low to the end of write cycle.
2. This parameter is sampled and not 100% tested.

Write Timing Waveform (1) ($\overline{\text{OE}}$ Clock)

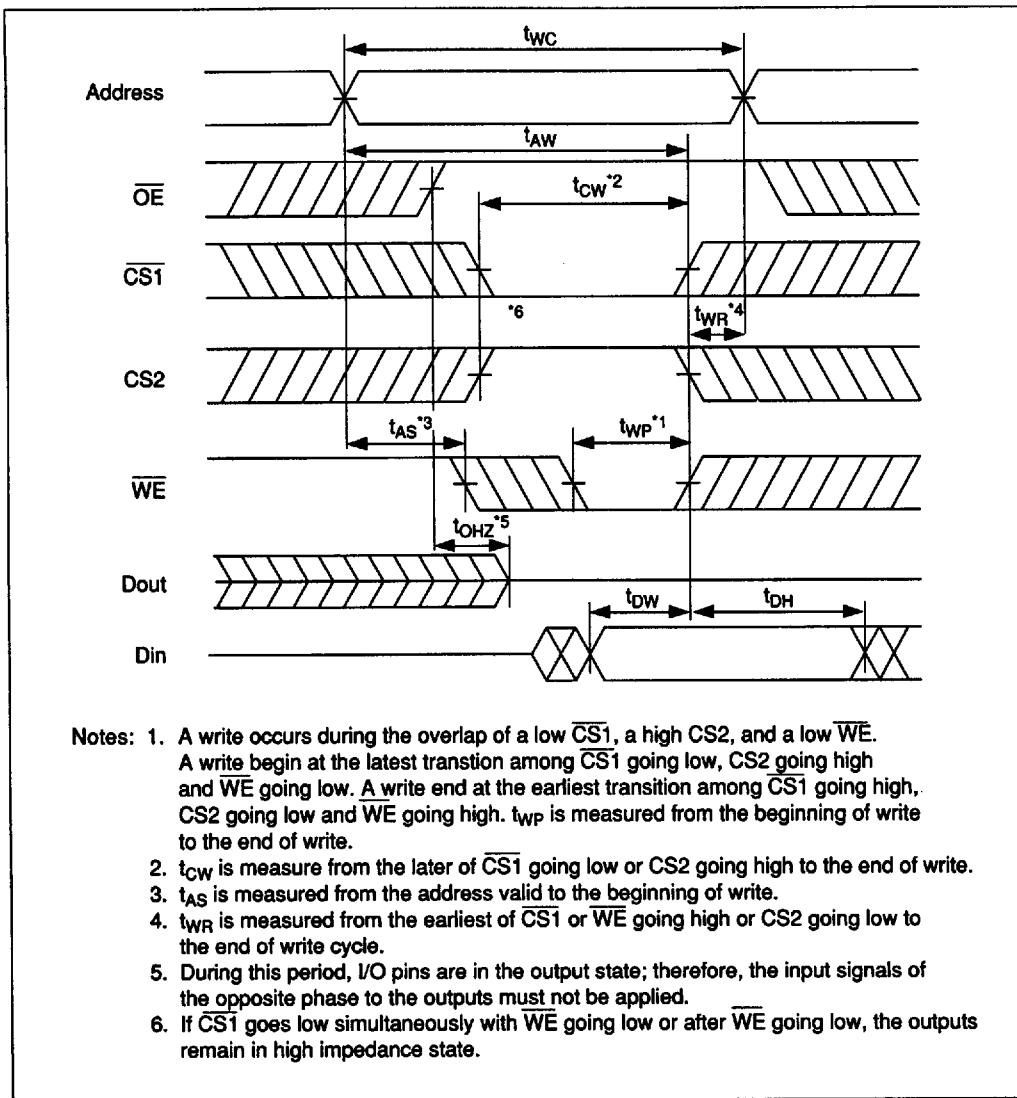

HM628128 Series

Write Timing Waveform (2) ($\overline{\text{OE}}$ Fixed Low)

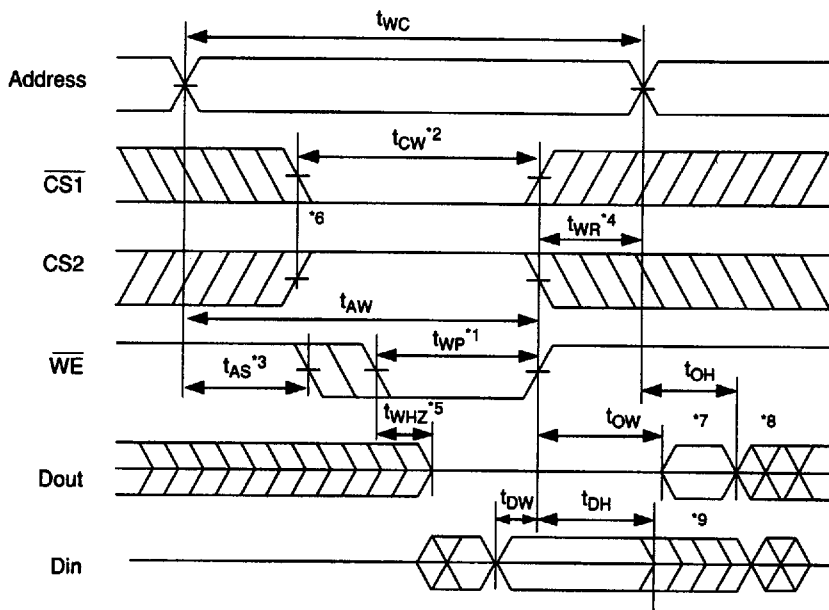

- Notes:
1. A write occurs during the overlap of a low $\overline{\text{CS1}}$, a high CS2, and a low $\overline{\text{WE}}$. A write begins at the latest transition among $\overline{\text{CS1}}$ going low, CS2 going high and $\overline{\text{WE}}$ going low. A write ends at the earliest transition among $\overline{\text{CS1}}$ going high, CS2 going low and $\overline{\text{WE}}$ going high. t_{WP} is measured from the beginning of write to the end of write. t_{WP} must satisfy the following equation to avoid a problem of data bus contention. $t_{WP} \geq t_{DW \text{ min}} + t_{WHZ \text{ max}}$
 2. t_{CW} is measured from the later of $\overline{\text{CS1}}$ going low or CS2 going high to the end of write.
 3. t_{AS} is measured from the address valid to the beginning of write.
 4. t_{WR} is measured from the earliest of $\overline{\text{CS1}}$ or $\overline{\text{WE}}$ going high or CS2 going low to the end of write cycle.
 5. During this period, I/O pins are in the output state; therefore, the input signals of the opposite phase to the outputs must not be applied.
 6. If $\overline{\text{CS1}}$ goes low simultaneously with $\overline{\text{WE}}$ going low or after $\overline{\text{WE}}$ going low, the outputs remain in high impedance state.
 7. Dout is the same phase of the latest written data in this write cycle.
 8. Dout is the read data of next address.
 9. If $\overline{\text{CS1}}$ is low and CS2 is high during this period, I/O pins are in the output state. Therefore, the input signals of the opposite phase to the outputs must not be applied to them.

HM628128 Series

Low V_{CC} Data Retention Characteristics ($T_a = 0$ to $+70^\circ\text{C}$)

(These characteristics are guaranteed only for L, L-L, and L-SL version.)

Parameter	Symbol	Min	Typ	Max	Unit	Test conditions*4
V_{CC} for data retention	V_{DR}	2.0	—	—	V	$\overline{CS1} \geq V_{CC} - 0.2\text{V}$, $CS2 \geq V_{CC} - 0.2\text{V}$, or $0\text{V} \leq CS2 \leq 0.2\text{V}$, $V_{in} \geq$
Data retention current	I_{CCDR}	L	—	50^{*1}	μA	$V_{CC} = 3.0\text{V}$, $V_{in} \geq 0\text{V}$, $\overline{CS1} \geq V_{CC} - 0.2\text{V}$, $CS2 \geq V_{CC} - 0.2\text{V}$, or $0\text{V} \leq CS2 \leq 0.2\text{V}$
		L-L	—	30^{*2}	μA	
		L-SL	—	15^{*3}	μA	
Chip deselect to data retention time	t_{CDR}	0	—	—	ns	See retention waveform
Operation recovery time	t_R	5	—	—	ms	

- Notes: 1. $20\ \mu\text{A}$ max at $T_a = 0$ to 40°C
 2. $6\ \mu\text{A}$ max at $T_a = 0$ to 40°C
 3. $3\ \mu\text{A}$ max at $T_a = 0$ to 40°C
 4. $CS2$ controls address buffer, WE buffer, $\overline{CS1}$ buffer, \overline{OE} buffer, and Din buffer. If $CS2$ controls data retention mode, V_{in} levels (address, WE , OE , $\overline{CS1}$, I/O) can be in the high impedance state. If $\overline{CS1}$ controls data retention mode, $CS2$ must be $CS2 \geq V_{CC} - 0.2\text{V}$ or $0\text{V} \leq CS2 \leq 0.2\text{V}$. The other input levels (address, WE , \overline{OE} , I/O) can be in the high impedance state.

Low V_{CC} Data Retention Timing Waveform (1) ($\overline{CS1}$ Controlled)

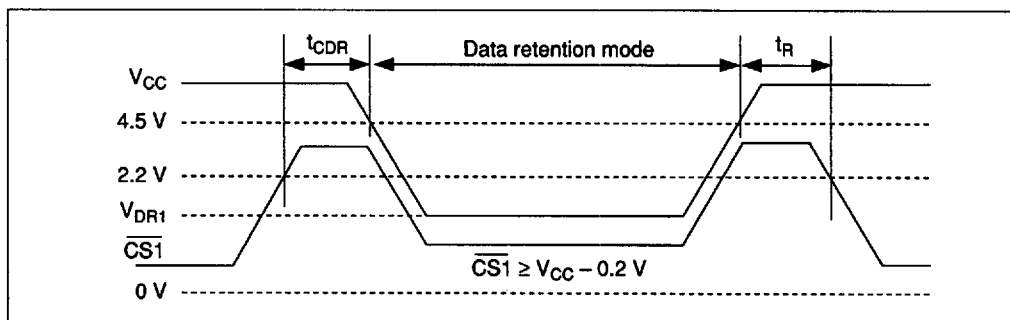

Low V_{CC} Data Retention Timing Waveform (2) ($CS2$ Controlled)

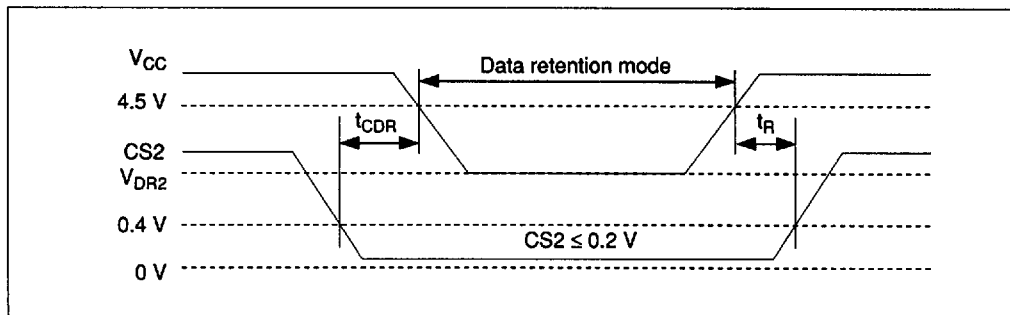

5

HM628128 Series

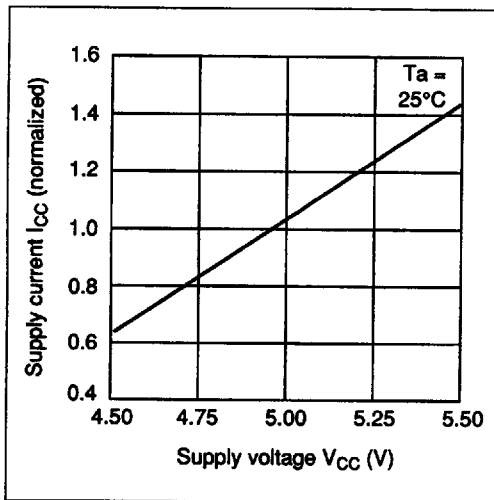

Supply Current vs. Supply Voltage (1)

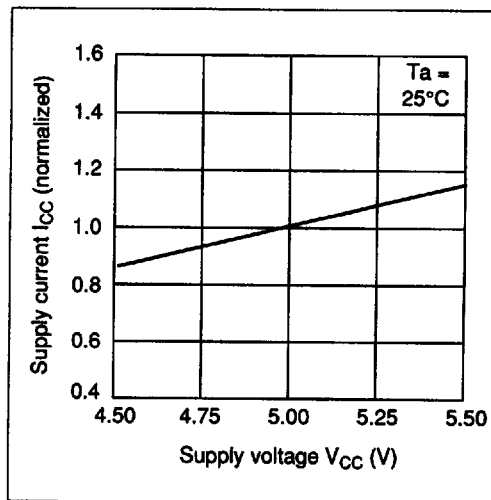

Supply Current vs. Supply Voltage (2)

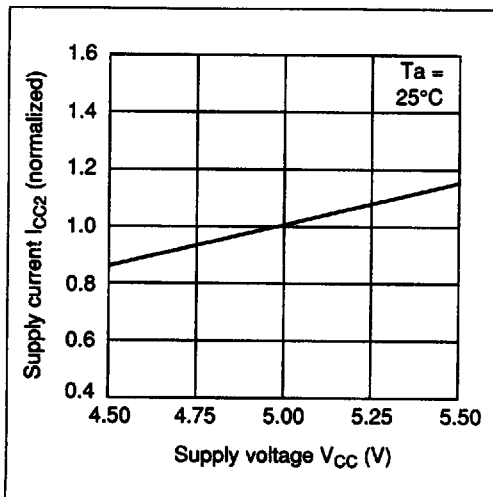

Supply Current vs. Supply Voltage (3)

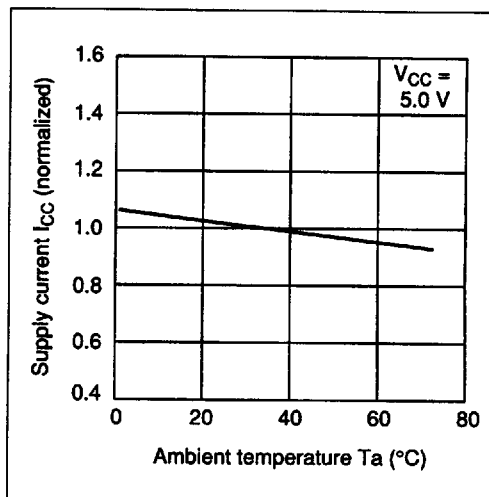

Supply Current vs. Ambient Temperature (1)

HM628128 Series

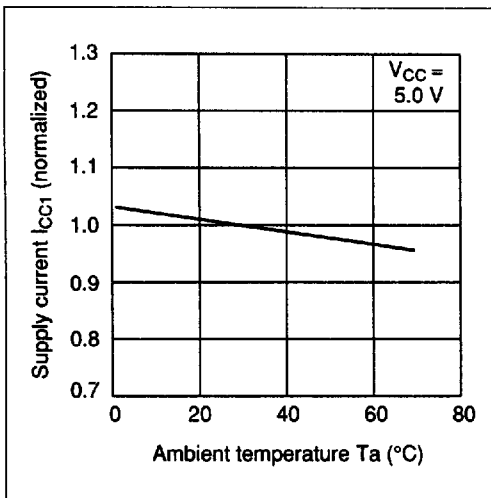

Supply Current vs. Ambient Temperature (2)

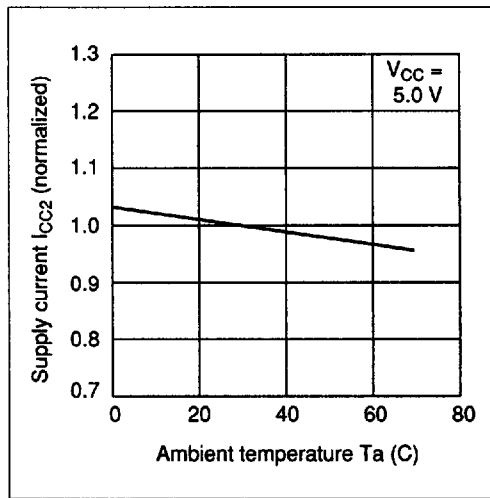

Supply Current vs. Ambient Temperature (3)

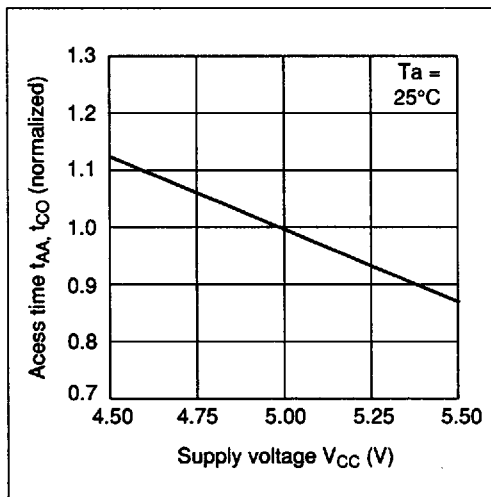

Access Time vs. Supply Voltage

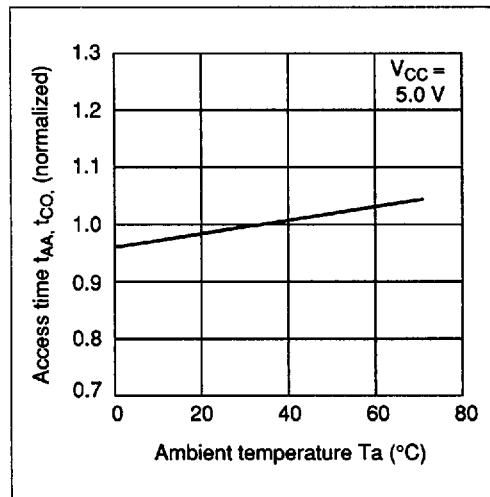

Access Time vs. Ambient Temperature

5

HM628128 Series

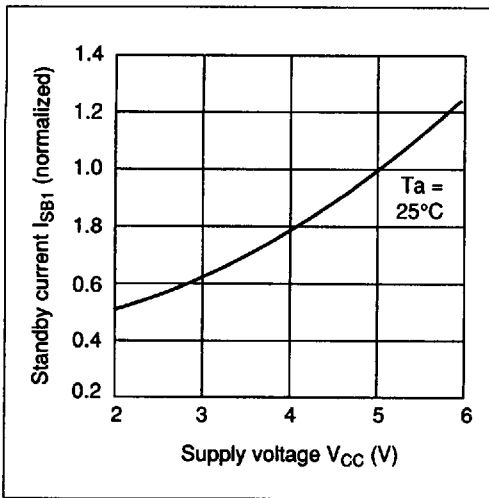

Standby Current vs. Supply Voltage

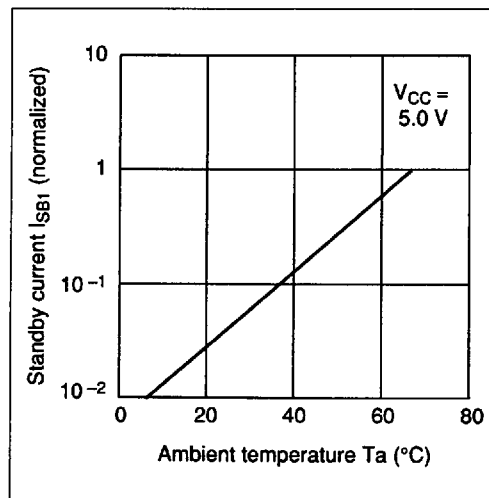

Standby Current vs. Ambient Temperature

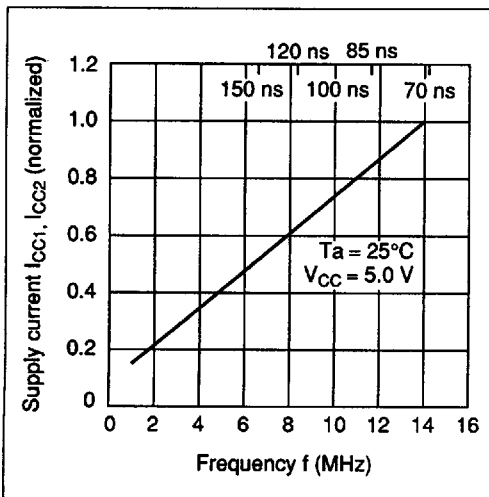

Supply Current vs. Frequency (Read)

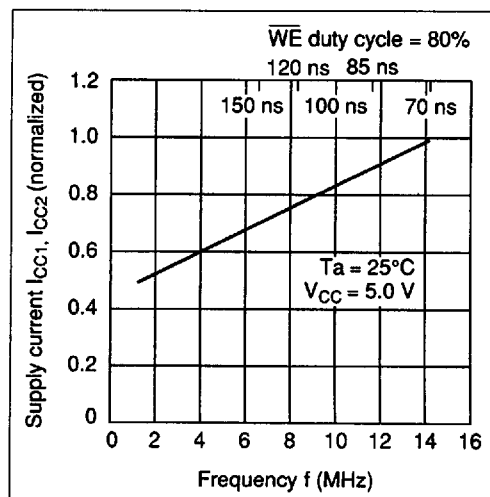

Supply Current vs. Frequency (Write)

HM628128 Series

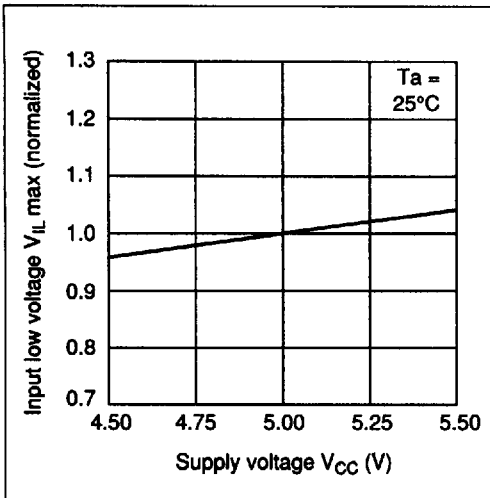

Input Low Voltage vs. Supply Voltage

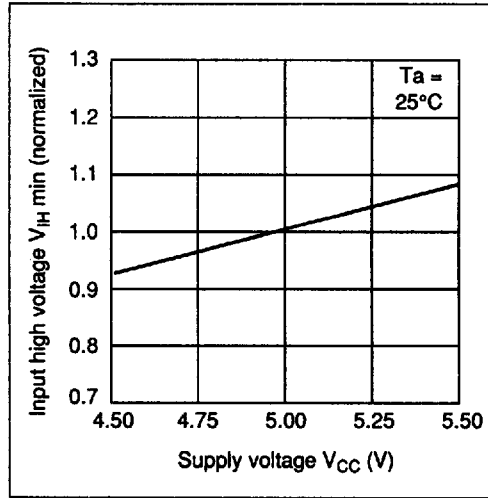

Input High Voltage vs. Supply Voltage

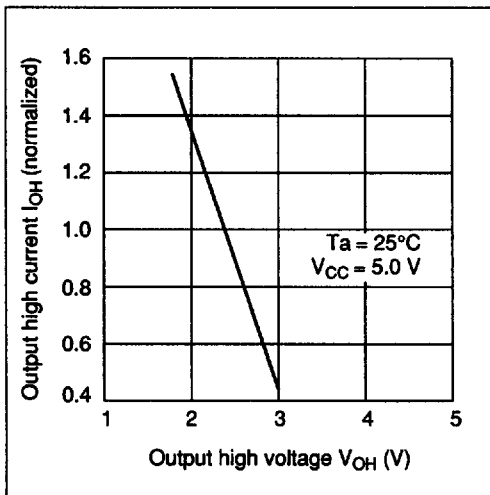

Output High Current vs. Output High Voltage

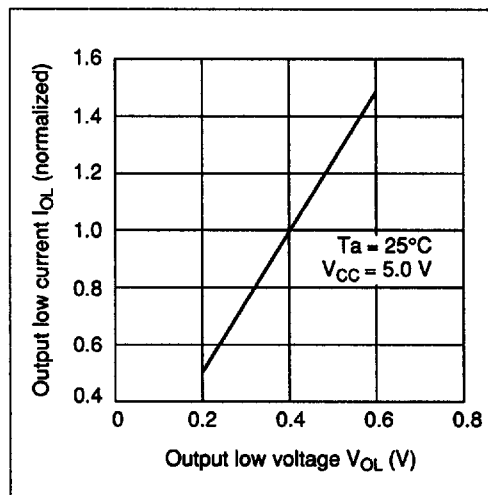

Output Low Current vs. Output Low Voltage

5

HM628128 Series

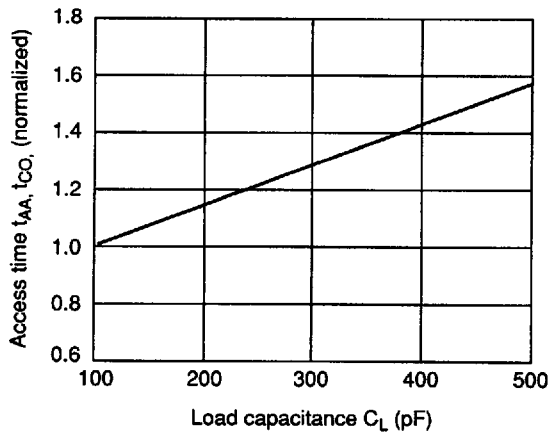

Access Time vs. Load Capacitance